

MINISTRY OF EDUCATION & TRAINING

MINISTRY OF CONSTRUCTION

HANOI ARCHITECTURAL UNIVERSITY

TRAN MANH CUONG

**THE VERNACULAR PRESENCES IN VIETNAM'S
MODERN ARCHITECTURE**

DOCTORAL THESIS SUMMARY

Department: Architecture

No: 62.58.01.02

HANOI- 2021

The thesis is developed in:
HANOI ARCHITECTURAL UNIVERSITY

Instructors:

- 1. PhD Architect. NGUYEN TRI THANH**
- 2. Assoc. Prof. Architect. KHUAT TAN HUNG**

Review 1: PROF. PhD. Nguyen Quoc Thong

Review 2: PROF. PhD. Doan Minh Khoi

Review 3: ASSOCIATE. PROF. PhD Pham Trong Thuat

**The thesis is reviewed by Hanoi Architectural University's
Doctorate dissertation review council**

On.....2021

More information can be found in:

- The National Library;**
- Hanoi Architectural University Library.**

OPENING

1. The reason of choosing this thesis

After the International Union of Architects Congress (UIA) on June 1999, modern architecture has begun to develop vernacularly, in a way each local characteristics and signatures are presented, enriching the cultural diversity of the new era. However, the globalization has had a negative impact on the vernacular presences in architecture in different parts of the country.

Vietnam VI Party Congress (12/1986) opened up a new stage of international integration for Vietnam when the globalization is progressing rapidly, with both upside and downside. After over 30 years, modern architecture as well as local architecture is at stake from the country's rapid development, which makes the vernacular vitality gradually less important.

The vernacular presence in architecture has been continuously shaped for centuries, for which it has met the practical demands and adapted to the social contexts. Nevertheless, it is now being taken out of the equation due to the uncontrolled urban planning, and numerous exotic architectural designs.

Moreover, researches, theoretical works and remarks on the vernacular presences in social fields and architecture haven't been formalized and unified to guide the architecture designing work. Documental translation cannot fully convey dynamic and the complexity of the vernacular concerns over the world at the moment, yet making local researchers rely on the Western perspectives. Therefore, it is of necessity to define the internals (the meanings) and the externals (the presences) of the vernacular traits to make the best use of it.

Vernacular directly relate to the way local society create not only their own architectural spaces and structural materials, but also the presences and expressions. Clarifying the components forming the vernacular in architecture and its characteristics will enhance the quality of the architecture in the localities. The Resolution of Vietnam XIII Party Congress also points out that we need to "Construct and enrich Vietnamese culture.. so that it can be the internal life force in the modern era".

With that remarks, the doctoral thesis is chosen to be "The vernacular presences in Vietnam's modern architecture" with the desire to contribute to Vietnam modern architecture a solid and renewed vernacular traits, meeting the practical goals of the country's development and the new era.

2. Research Purposes and Goals

- **Purposes:** Clarify the ways vernacular is presented in architecture.
- **Goals:** 1/Identify the vernacular presences in architecture corresponding to the vernacular surroundings; 2/Construct a criteria system to identify the vernacular presences in Vietnam's modern architecture; 3/Regulate and raise the effectiveness of vernacular presences in Vietnam's modern architecture.

3. Research subjects, scope and limitations

- **Subjects:** The Internal (the meaning) and the External (the presentation) of the vernacular in architecture.

- **Scope and Limitations:** Among the contemporary architectural works. Around the globe it is considered as the Late Modern period (after 1991), which is often related to the end of Modernism (1945 – 1990). In Vietnam, the Contemporary era is considered as the Reform and Interim period (from 1986 till present).

4. Research Methods

The thesis uses a combination of these basic researching methods: 1/Documents research; 2/Analysing and Synthesizing; 3/Analyzing the structures; 4/Systematizing; 5/Compare and Contrast.

5. Research Content

1/. Systematize the ideologies and knowledge of the vernacular in architecture; 2/. Construct the theoretical basis on the vernacular presences in architecture; 3/. Identify the structure of the local vernacular surrounding and the ways vernacular is presented in architecture; 4/. Construct a criteria system to identify the vernacular presences in Vietnam's modern architecture. 5/. Propose optimization and improvement on the effectiveness of the vernacular presences in Vietnam's modern architecture.

6. Theoretical and practical valuation of the thesis

- Theoretical valuation: The thesis is a theoretical research containing the theoretical basis and systematized ideologies on the vernacular in architecture, to help architectural theoretical researches and reviews, as well as education.

- Practical valuation: The thesis is a reference for architects with their designing process; therefore contribute to pilot the development and improvement of the vernacular presences in Vietnam modern architecture.

7. Results and Contributions

The thesis has contributed to the theoretical system of the architecture department these following results:

1/. Clarify the structure of the vernacular in architecture, identify the ways of presences and different aspects of the vernacular corresponding to the local vernacular surrounding, to systematize the theoretical basis and knowledge on the vernacular in architecture;

2/. Construct a criteria system to identify the vernacular presences in Vietnam urban architecture (including 7 groups with 25 criteria). The criteria system has been applied in some specific architectural works to identify the vernacular presences;

3/. Propose the oriented perspective, some principles and methodologies to enhance the effectiveness of the vernacular presences in Vietnam's modern architecture; and can develop into architectural designing methods to present the vernacular in practical works.

8. Terminology

The thesis clarifies these terminology: 1/National identity; 2/Folk architecture; 3/Traditional architecture; 4/Natural ecological environment; 5/Vernacular presentation method; 6/Tradition; 7/Culture.

9. The thesis structure

The thesis consists of three parts (Opening – Content – Conclusion and Recommendations) and other appendix. The Content is presented in three chapters:

- Chapter 1. Overview of the vernacular presences in Vietnam's modern architecture.

- Chapter 2. Theoretical basis of the vernacular presences in Vietnam's modern architecture.

- Chapter 3. Regulate and raise the effectiveness of the vernacular presences in Vietnam's modern architecture.

CHAPTER 1. OVERVIEW OF THE VERNACULAR PRESENCES IN VIETNAM'S MODERN ARCHITECTURE

1.1. TERMINOLOGY

Chapter 1 clarifies the terminology: 1/Vernacular; 2/The vernacular characteristics; 3/Vernacular architecture; 4/Identity; 5/Local identity; 6/The vernacular presences in architecture.

1.2. HISTORY CONTEXT OF VERNACULAR IN URBAN ARCHITECTURE

1.2.1. Mutual context concerning Nation – Tradition – Vernacular

The development phase from Nation → Tradition → Vernacular has a general progress below:

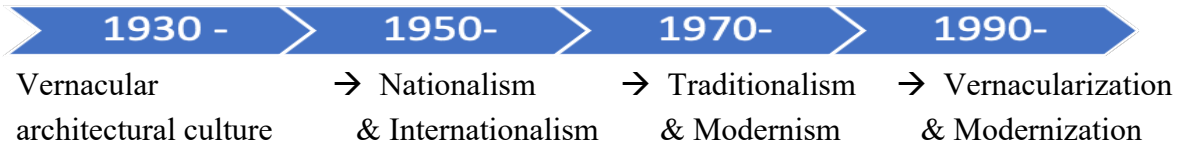

1.2.2. Nationalism and Internationalism in architecture

Nationalism in architecture is considered as a basic requirement as well as Modernism and Internationalism. The traditional values need to be put in dialectical relationship with modernization requirements with diverse approaches to utilize, develop, reform and innovate. Practical tradition values are presented in architecture in many big countries (Russia, USA, China, Japan, India...) as well as the old colonies. The basic elements impacting the national characteristics – or National Identity in architecture are: 1/ External elements: natural and geographical conditions; 2/ The subjective elements: the architects' creativity; 3/ Specific economic, historical and sociocultural settings in different regions.

1.2.3. Traditionalism and Modernism in architecture

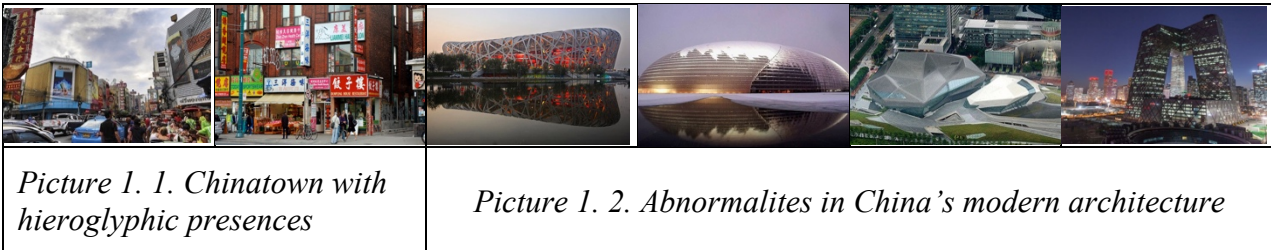

Once a nation and its people is united (geographically), is independent (both economically and traditionally), and the freedom belongs to its people (without any constraints and assimilation), then restoring, consolidating, or emphasizing Nationalism becomes less important – but to preserve, advance and modernize the existing traditional matters and values. These need to be put under a dialectical relationship with modernization requirements, with diverse approaches to utilize, develop, reform and innovate.



1.3. REDIRECTION TO VERNACULAR IN MODERN ARCHITECTURE

1.3.1. International context leading to vernacular concerns in the end of 20th century

During the later half of the 20th century, the world had been witnessing transformations in both the society and social awareness, towards the situation where the vernacularism needs to be addressed. In the XX UIA Beijing, it was stated that “To make modern architecture vernacular” together with “Modernize vernacular architecture”. “Vernacularization with Modernization” can be nations' strategy to overcome the nationalism issues, which can be considered as a cultural preservation, to have a firm stance in international diplomacy and cooperations.

1.3.2. Vernacular in Globalization context

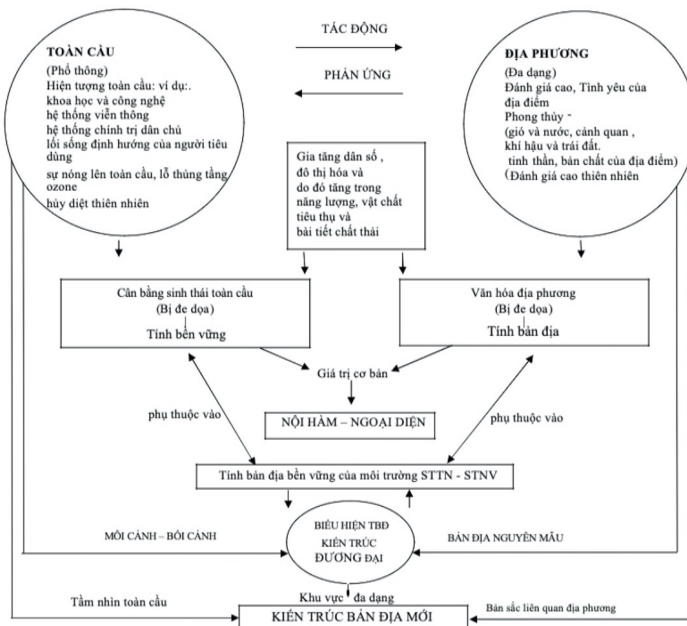

Picture 1. 4. Global and Local in modern context

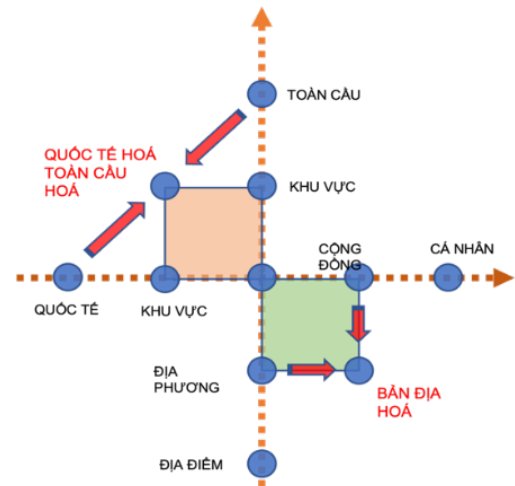

Picture 1. 5. Vernacularization in relationship with Globalization

Globalization includes both internationalization and regionalization, which have a close relationship with each other. In history, there have been 2 globalization movements, and this is the third, which raises more concerns because of its rapid and strong pace, together with a wider spread. All three movements came from the Western, but they have different results. Therefore, the vernacular in the globalization context not only happens within the nation but also in regional and global organizations, in one multinational unification.

1.3.3. Vernacularization trends in modern architecture

The local architects has combined Western architectural achievements with researches on traditional architecture on the country’s climate condition and sociocultural traits to design modern architectural works but still preserve the national and local identity. Countries around the world also apply method originated from symbolized history, nature, to advanced technology to bring life to architecture.

1.3.3.1. Regionalism and New Regionalism:

Table 1. 1 Featuring architects of New Regionalism			
Hassan Fathy (Egypt)	Charles Correa	Raj Rewal (India),	Geoffrey Bawa (Sri Lanka)
Tadao Ando (Japan),	Glenn Murcutt (Australia),	Alvaro Siza (Portugal),	Rafael Moneo (Spain)

1.3.3.2. Global architecture adapted to the Local:

By the end of the 20th century, the concept of Glocal had been conceived , "locally adapted globality" or "the world in the style of the local". Glocal is a combination of Global and Local, a reconciliation between globalization and localization. The concept emerged in the early 1990s, adapted to the Japanese word "dochakuka" – that is, to make farming techniques (cultivation and breeding) adapt to the conditions of a defined locality. It later became popular and officially recorded in The Oxford Dictionary of New Words (1997).

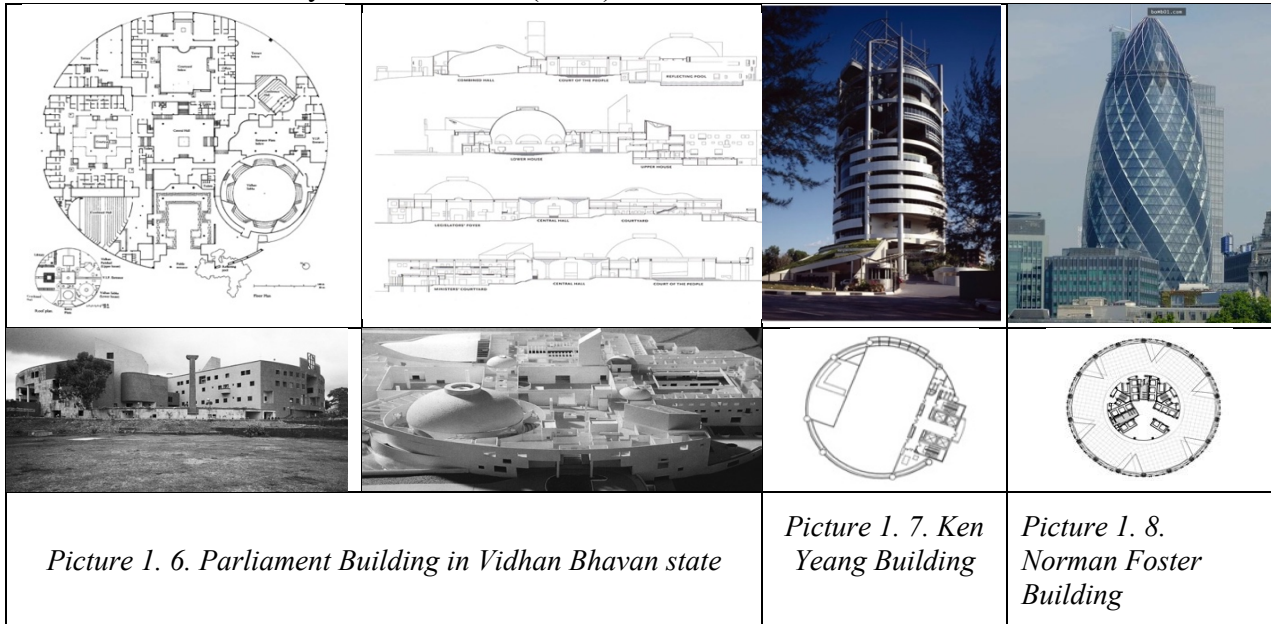

1.4. CURRENT CONTEXT OF VERNACULAR PRESENCES IN VIETNAM’S MODERN ARCHITECTURE

1.4.1. The vernacular presences in Vietnam’s architecture before 1986

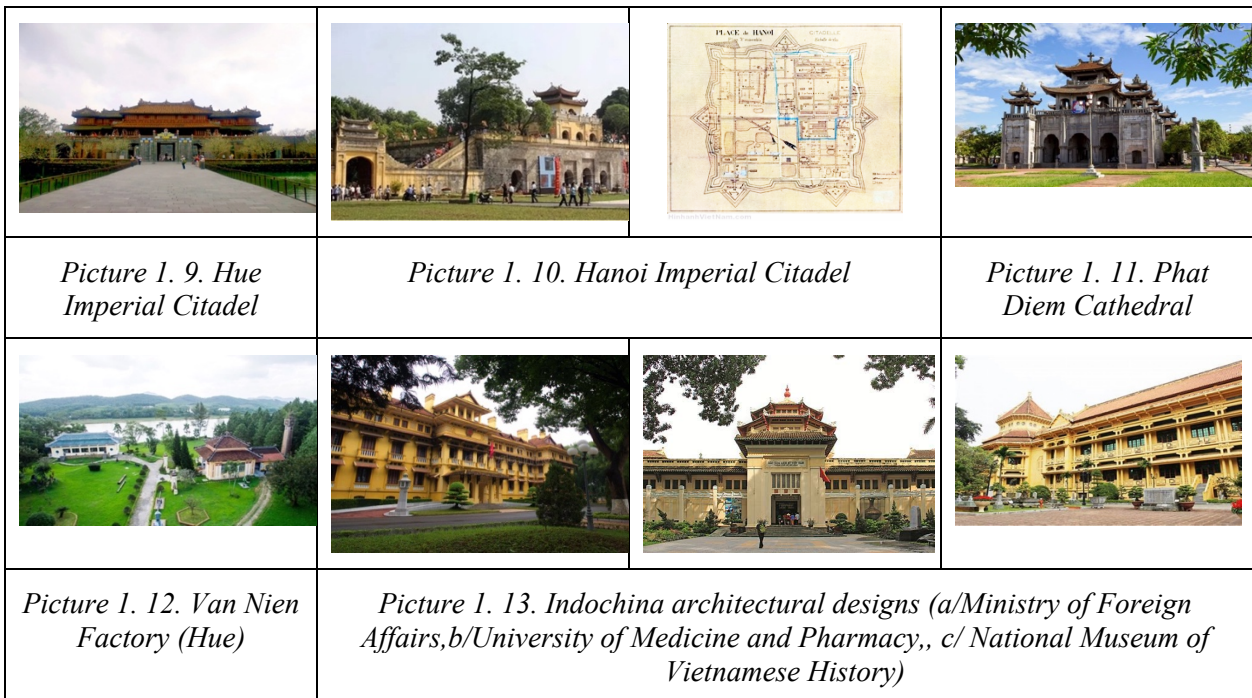

During the feudal period, various types of folk houses, communal houses, pagodas, temples, shrines,.. in the rural areas have the same presentation and structure (only different in sizes, materials, scales and decorations); architecture in the traditional cities also follow a fw common forms – adapted to narrow lands and developed in height.

1.4.2. The vernacular presences in Vietnam's architecture after 1986

From 1986 till present, Vietnam's architecture has transformed into a new cultural system of a transitional period of "advancement and national culture" to "unify but not dissolve". In such system, the vernacular presences catches many architects' interest in basis of vernacularization within modern architecture and modernizing the vernacular to present a new modern architectural movement and Vietnam's modern architecture in general.

Picture 1. 2 The vernacular presences in some modern Vietnamese architects







			
Trường Đại học Kiến trúc Hà Nội	Bảo Tàng ĐăkLăk	Bảo tàng Điện Biên Phủ	Trung tâm Hội chợ triển lãm Hải Phòng
			
Chợ Đông Hà, Quảng Trị	Trung tâm hội nghị quốc tế Hà Nội	Trung tâm VH Kinh Bắc (Bắc Ninh)	Đài tưởng niệm Bắc Sơn, Hà Nội

Table 1. 3 Vernacularization in some foreign architects' works in Vietnam







				
Cung VH Lao động Hữu nghị (Hà Nội)	Bảo tàng Hồ Chí Minh	Thư viện và Bảo tàng Quảng Ninh	Bảo tàng Hà Nội (hoàn thành XD)	
				
Trung tâm hội nghị quốc gia Mỹ Đình	Nhà Quốc hội VN	Prime Center 53 Quang Trung	Khu nhà ở Dolphin Plaza Hà Nội	Bitexco Financial Tower (Tp.HCM)

Table 1.4. Specialists perspectives

1.5. CURRENT RESEARCH CONTEXT ON VERNACULAR IN ARCHITECTURE

1.5.1. Researches around the world

Studies in Western countries are mainly individual studies of a specific type of vernacular architecture in different regions and localities. The aim is to clarify the lessons learned from the past, to preserve and exploit the value of the existing folk architecture, not to apply to the "vernacularization" of new buildings, because the overall construction environment is stable. As Thomas Hubka studied the architecture of synalymys in Eastern Europe, farm architecture in New England, USA; A. Rappaport "House Form and Culture", (1969), which examines the form of folk housing patterns in the tropical belt and shows the link between indigenous KT and VH through the common subject of ethnicity; Paul Oliver with "Dwelling - The House across the World" (1987), "Encyclopedia of Vernacular Architecture of the World" (1997), and "World Atlas of Vernacular Architecture" (2005).

1.5.2. Researches in Vietnam

Overall, Vietnamese studies have mostly focused on the link between original vernacular factors (natural climate conditions and sociocultural environment) and the characteristics of folk architecture and traditional architecture.

- About folk housing architecture: Nguyen Cao Tuong "From traditional thaty roofs", (1977); Nguyen Khac Thuc "Home of the Midlands of North Vietnam", (1978); Chu Quang Truc "Traditional Vietnamese Folk Architecture", (2003).

- On the issue of National Identity in architecture: Workshop "Globalization and identity in architecture" of the Vietnam Association of Architects, (2000); The collection "Discussing ethnic and modern issues in Vietnamese architecture" by the Institute of Architectural Research (1999).

- Regarding the relationship between architecture and traditions: There are the thesis of Dr. Nguyen Dinh Toan "Natural factors and indigenous VH traditions in French colonial architecture", (1998) and Of Dr. Khuong Tan Hung "The connection between traditional housing architecture and folk housing architecture in the Vietnam Northern Delta", (2007).

- On the relationship between architecture and climate: Nguyen Huy Con "Climate - Architecture - People", (1985) and "Architecture and Environment", (2004); Hoang Huy Thang "humid tropical architecture"; Tran Quoc Thai "Sustainable Architecture from a Local Climate Adaptation Perspective", Doctoral Thesis, (2006); Pham Duc Nguyen "Climate Architecture", (1997).

- Regarding the study of transforming traditional sociocultural characteristics into the design of "localization" of the architecture of performance works, there are: Nguyen Tri Thanh "Cultural factors in performance architecture in Vietnam", Doctoral Thesis, (2004) refers to the symmudic relationship between CTBD and the sociocultural environment of the venue; Vu Duc Hoang's thesis summed up the issue of exploiting the characteristic elements of the place (natural landscape elements and indigenous socioculture) to create a local identity for the architecture of resort resorts (especially from the experience of resorts in Southeast Asia).

1.5.3. Problems to be solved in the thesis

In general, the research works talk a lot about local identity in architecture but there is no comparison and connection with the research results in the field of VH learning about the VH identity of the people according to the subject, of the locality, the region. Some studies have homogeneted identity with external characteristic elements and signs (proportions, lines, materials, decorations,...). The identification of which indigenous being "original" (not externally influenced - essentially the folk, traditional, in feudal period) or "new" (there has been interference and transformation, in modern and modern periods) is not clear, nor does it indicate which indigenosity is the nature throughout the periods to continue to the contemporary. great.

From the above research issues, it is necessary to preserve and exploit the promotion of labor in E-commerce, it is necessary to focus on the following key issues:

1/ It is necessary to study the vernacular presences in architecture, thereby systematizing the cognitive reasoning of the vernacular in Vietnam's modern architecture.

2/ It is necessary to develop criteria to identify the vernacular presences in Vietnam's modern architecture.

3/ It is necessary to propose the vernacular presences in Vietnam's modern architecture.

4/ It is necessary to make proposals on orientation to promote the vernacular presences in Vietnam's modern architecture as well as national identity.

CHAPTER 2: THEORETICAL BASIS OF THE VERNACULAR PRESENCES IN VIETNAM MODERN ARCHITECTURE

2.1. Opinions on the vernacular characteristics and research approches

2.1.1. Opinions on the vernacular characteristics

With the view that "indigenosity" is similar to "local identity" (as well as the chain of relationships: vernacular = indigenous vitality = local vitality = local identity), and Identity =

Nature/identity (only inherent, internal) + Nuances/degrees (only the degree of outward expression)
 - the structure of the problem of vernacular in architecture is similar. it is itself of "identity", i.e. consisting of the Internal (general concept) and External (specific appearances).

- Internal: 内函 = The content inside – The thesis’s point of view on “vernacular” and “vernacularism” in architecture.

- External: 外面 (Traditional) / 外面 (Simplified) = The outward show, the appearance.

- “External” therefore is different from “Extension” (外衍). “Extension” is a philosophy term, is categorized in the same group and in opposition with “Internal” - is a set of all objects whose characteristics/properties are stated in the content. Relating “the vernacular in architecture”, External is the general concept of vernacularism in architecture works (like several Western researches). Meanwhile, Extension represents the architecture elements and components directly related to the vernacular of a building, in a specific and detailed way.

- Vernacular in architecture is a common characteristic, but a detailed presentation of vernacular may change through time and space – in which the unchanging elements are determined, while the uncertainties is dependent on the characteristics of the local area and other external difficulties. Consequently, the researches of the thesis will concentrate on clarifying the relationship / transformation from the Internal (the content / the depth of structure) to the External (the presentation / the outer structure) – which is the way and the structure of presentation of the vernacular in architecture.

2.1.2. Research Approaches

In the past, folk architecture as well as traditional architecture often show the vernacular presences clearly – as it is the indisputable result of both existing natural ecology and human ecology. Nowadays, the human ecology has been advancing significantly and somehow overwhelmed the natural ecology – so presenting and sensing the vernacular architecture which contains the traditional identity depends on shaping intention and designing solution, and has become an obstacle to overcome by ideas and enthusiasm and to be carried out by human’s will and capability. Therefore, the vernacular presences in architecture needs to be analyzed from the human’s perspectives (which is both the constructing perceiving subject), representing the community (with the majority of agreement). Thus, the thesis needs to approach this obstacle with the way of Adaptation – from the humane and social perspective (in general), cultural studies and linguistics (in specific aspects) – then combine them with Structuralism methodology (because the nature of architect is a system of structures).

2.1.3. Structure of the vernacular presences in architecture

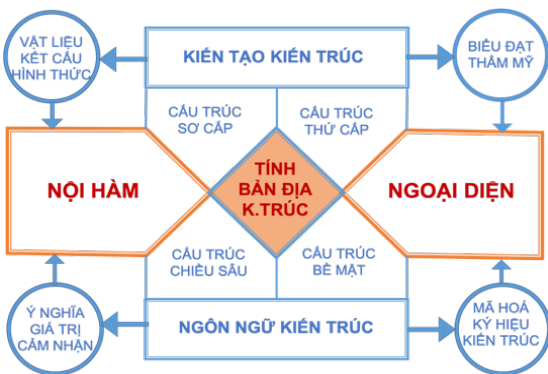

Picture 2. 1. Structure of the vernacular presences in architecture

Table 2. 1. Elements of the vernacular presences in architecture

Cấu trúc biểu hiện của tính BD	
Nội hàm: Nhận thức / ý niệm về "tính BD trong kiến trúc"	Ngoại diện: Sự biểu hiện tính BD bằng ngôn ngữ kiến trúc
Các yếu tố / thành phần	
Cái bất biến (ổn định): - Tác động từ các nhân tố BD nguồn (điều kiện TN và truyền thống VH) - Tiếp nối truyền thống - Từ quá khứ / lịch sử	Cái khả biến (thay đổi): - Con người và XH (tiếp biến VH) - Vật chất và kỹ thuật (hiện đại hóa) - Có thời điểm, thời hạn - Hướng tới tương lai
Cấu trúc sơ cấp: - Kiến tạo kiến trúc (Vật liệu - Cấu trúc - Hình thể)	Cấu trúc thứ cấp: - Hình thức kiến trúc (Phản ánh nội dung, biểu đạt thẩm mỹ)
Cấu trúc chiều sâu: - Nội dung, tính chất, ý nghĩa Cảm xúc và nhận thức (cái cảm thấy)	Cấu trúc bề mặt: - Hình thức, dấu hiệu, biểu hiện Thông tin thị giác (cái nhìn thấy)
Phương thức biểu hiện của tính BD	
Thông tin BD → Mã hóa → Ký hiệu BD	Ký hiệu BD → Giải mã → Cảm nhận BD
Phương thức mã hóa: - Ẩn dụ / Biểu trưng	Phương thức cảm nhận: - Liên hệ và liên tưởng

2.2. THEORETICAL BASIS ON THE RELATIONSHIP BETWEEN ORIGINAL VERNACULAR ELEMENTS AND ARCHITECTURE

2.2.1. Architecture adapted to the natural ecological and human ecological environment

2.2.1.1. Architecture adapted to the natural ecological environment



Picture 2.2. F.L.Wright

Natural environment (environment and landscape) is the factor of the original vernacular elements leading to the formation of vernacular prototypes in architecture. In general, the factors of terrain, climate, sun, wind, rain,.. decide the morphology and structure of folk/indigenous architecture in every locality. Topography (slope and geomorphology) has always been an objective predeso factor (of heaven and earth), related to the great stature (mountains, rivers), which govern both the climate and the landscape. The architecture adapts to

the natural environment, people feel conveniently suitable and attached to the location. In the past, the natural environment was still seen as immutable/stable – but now there is climate change on a global scale that contemporary architecture must find a way to adapt to.

2.2.1.2. Architecture adapted to human ecological environment

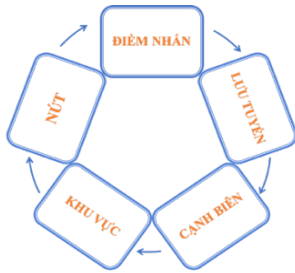

Picture 2. 2. Urban Identity (by Kevin A.Lynch)



Picture 2. 3. Urban Identity elements (by Prof. Hoang Dao Kinh)

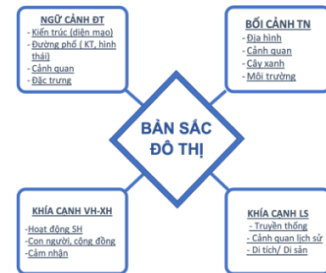

Picture 2. 4. Thesis's perspective on Urban Identity

2.2.2. Western theoretical basis on the relationship between Place and Architecture

2.2.2.1. Theory about “Place”

In Architectural Phenomena study, "place" is the core issue of the organic relationship between buildings and people and nature. "Architectural design is about making the spirit of place visible and the task of architects is to create meaningful places to help people live happily" (Christian Norberg-Schulz).

2.2.2.2. Theory about “Place’s vitality” and “Place’s identity”

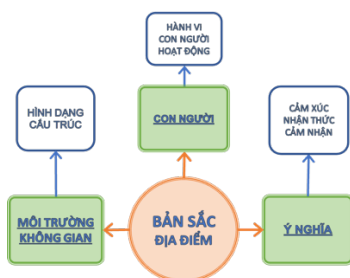

Picture 2. 5. Structure of Place's Identity

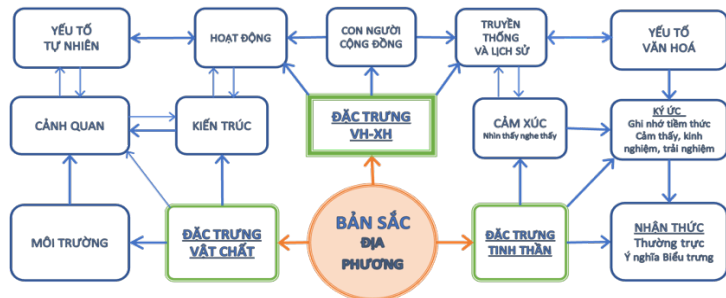

Picture 2. 6. Local Identity's characteristics and aspects

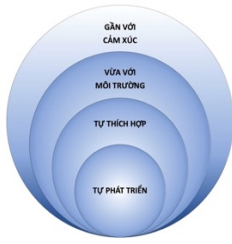

Picture 2. 7 Level of Place's Identity

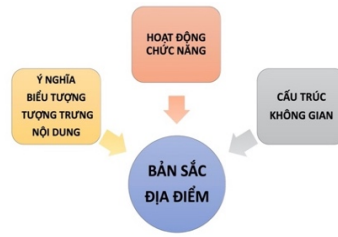

Picture 2. 8. Elements of Place's Identity

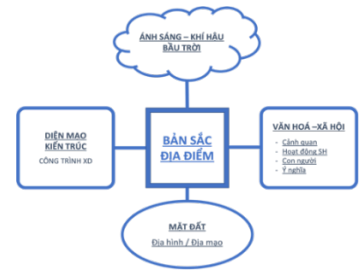

Picture 2. 9. Place's Identity

2.2.2.3. Lý luận của Phương Đông về mối liên hệ giữa kiến trúc và địa điểm

The way people handle elements of the construction site expresses the philosophy of life (human perspective and world view), expressing how we treat the environment. In The East Asian philosophy, there is a strong, indivisible connection between man and nature. Thus, the architecture that is in line with the location is the architecture that is suitable for the characteristics of the environment, creating long-term stability in relation to the elements of the surrounding environment; contributes to the improvement - even remediation - of adverse factors for humans to be able to reside permanently in that location.



Picture 2.11. Yin - Yang



Picture 2.12. Three Talents

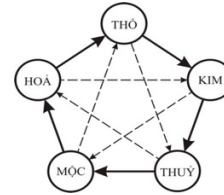

Picture 2.13. Five elements

2.3. THEORETICAL BASIS ON VERNACULAR PRESENCES IN ARCHITECTURE

2.3.1. Theoretical basis between Culture and Architecture

2.3.1.1. Structure and Operation of the Cultural System

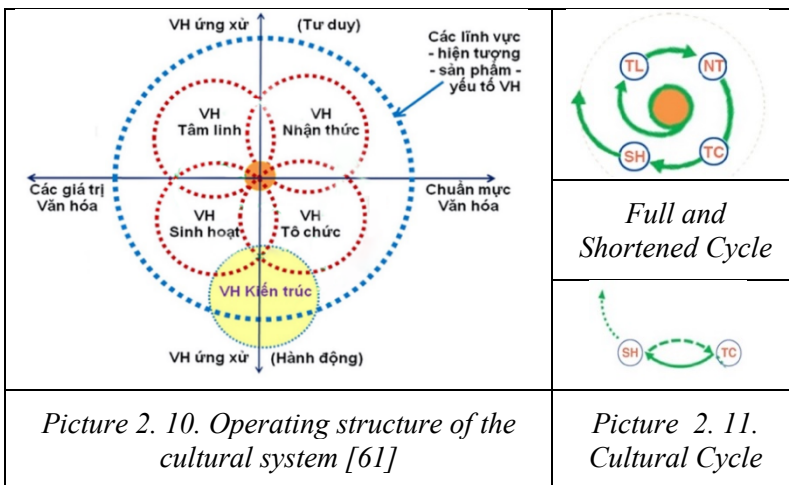

The structure of the cultural system consists of: basic components (Cultural Spirituality, Cultural Awareness, Cultural Organization, Cultural Living); Consciousness (the intersectional domain of cultural elements, which is the root, the beginning of the cultural process and governs the elements); Standard axis - values and cultural behavior (is the framework that shapes the cultural system); secondary cultural fields/phenomena/products (including architecture and cultural architecture) are formed and accumulated in the outer ring, forming the diverse and vivid exterior of the cultural system. When cultural standards and values are in line with practice, the cultural system operates with a repetition of shortened cycles (between cultural Organization and Cultural Living). When conflict arises, the system begins full cycles (through cultural Spirituality and Cultural Cognition) to form new norms (-> cultural filter mechanisms).

2.3.1.2. Cultural basis of architecture

Architecture as a cultural product is made up of material, social and spiritual elements. The material element is the structure of the object components, including physical and physical characteristics (thereby distinguishing objects although they may be similar in material and structural principles). The social element is the function that meets the needs of people. The mental element is the response to internal needs (aesthetic, spiritual, emotional, cognitive, moral, thought,..), human expression and the human world view. Architecture is the supporting cultural relationship between the object and the intangible, consciously created by man and connected to serve his material and spiritual needs. With the problem of vernacular in architecture, nature does not impose expression but opens up many different possibilities, and culture is the determinant of specific choices and human behavior.

2.3.2. Theoretical basis on visual language in architecture

2.3.2.1. Presenting structure of visual language

The issue of vernacular insurance should be considered from the structure and expression of the architectural language. Semiology (Semiology, [87], [101]) considers language to be a system of three elements: Realism (what is specifically referred to, Referent) + Symbol (what is used for expression, Signifier) + Meaning (what is expressed, Signified), which forms the semiotic triangle (Figure 2.16). In visual forming languages, the lackluster presence of "plants" is only part, one aspect of the symbol form, the intermediate hiccup between "symbol" and "meaning." For simplification, in architectural symbolism it is possible to view vc elements - form as what is meant, the signifier / symbol; And the social and spiritual elements are what are meant, what is expressed (Signified / Reference). What means what is meant to BH, what is meant by what is meant to become valuable - they are linked to coexistence and benefit each other, i.e. symbiotic Culture together.

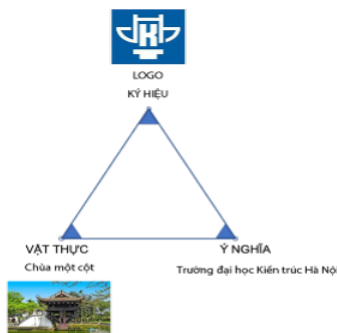

Picture 2.17. Triangle of semiotics

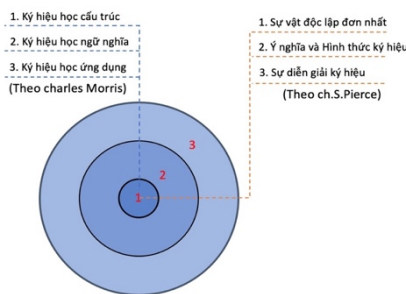

Picture 2.16. Modern semiotics

Modern semiotics (initiated by Charles Sanders Peirce and developed by Charles Morris) acquire all three components in a unified structure, penetrating each other and enclosing each other – in the style of 3 concentric circles / 3 classes (figure 2.17). Ch.S. Peirce (1839-1914) is based on the philosophy of concepts (meaning, expression, symbol) and considers logic as the universal law of necessity (Symbolology = Logic) the three-tiered conception is: the symbol itself (which is an independent, single thing), the meaning and form of the symbol (which has a parallel relationship, meaning to another thing), and the interpretation of symbols (three-dimensional interaction, is the structure of depth, the whole symbol). Ch. Morris (1901-1979)[129] promoted semiotics as the "organizational science" of the social-human disciplines, focusing on the relation of symbols to objects, to humans, and to other symbols – for those three tiers: Structural notation (study of the composition, structural organization of symbols), Semantic notation (study of the types of expressive meanings of symbols) and applied notation (study of the origin, usage and effect of symbols, the relationship between symbols and users - i.e. Pragmatics / Linguistics). Accordingly, Structural Symbolism is the first

floor in the innermost and part of the semantic notation on the 2nd floor, while applied symbolism is

the third layer that covers the whole. However, visually, these patterns are contrary to conventional visualization (usually what is "surface" is external, what is "deep" is inside).

2.3.2.2. Ways of presenting visual language

Visual cues and images account for the majority (60-65%) of the information humans receive from surrounding environment (70% more than all other senses combined). And a third of the cortex is mobilized to process this amount of information. The light reflected from the object is converged by the retina including rod-shaped and light-sensitive cone receptors. Nikos Metallinos (in Moore & Dwyer, 1994, p.60-61)[130] considers visual stimulation to be "electromagnetic energy, due to objects acting on the retina of the eye". The retina converts light rays into electrochemical signals, which then pass through the optic nerve to the visual cortex area in the back lobe of the brain. There are different pathways related to color, movement, depth and shape, structure, but the brain integrates into a single perception. Once the signal has passed through the retina, then in particular "sight" no longer makes sense. The fact that the brain perceives a homogeneity instead of five (corresponding to the five senses) suggests a combination of visual information with information from other senses, as well as with existing memories and knowledge. It is the process of "awareness" with the formation of **meaning** concept.

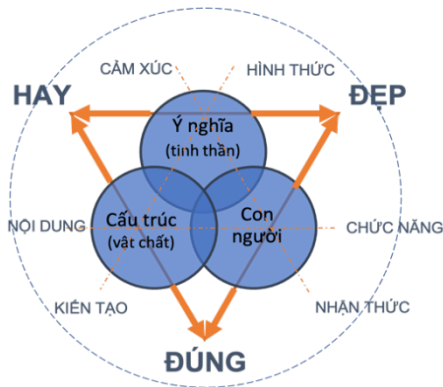

Picture 2.12. Levels of visual language expression

2.3.3. Elements relating the vernacular presences in architecture

2.3.3.1. Aspects presenting vernacular

Adapting flexibly to life, with environment and climate being the vital requirement of architecture in the past as well as in the present and also in the future. Vietnam architecture must be in line with the lifestyle, customs and psychology of the Vietnamese people and adapt to the tropical climate. From the relationship between architecture and Natural Ecology, SocioCulture and Material - Technical (Materials-Architecture) that contains it – the vernacular or Local Identity is reflected mainly in 3 aspects, meeting all three of these environment

simultaneously (Picture 2.19). These are: - **Adaptation, Conformity, Inclusion.**

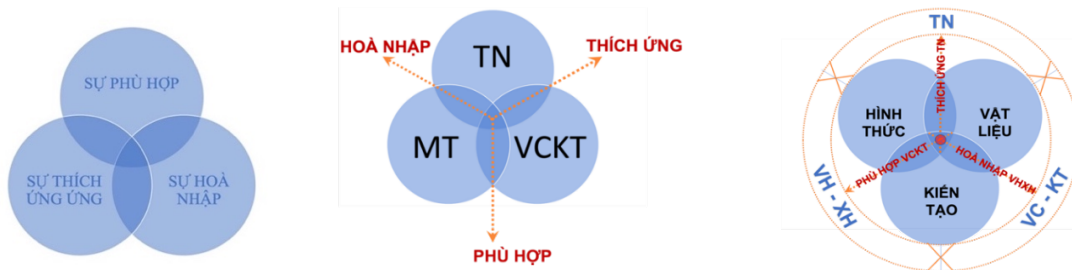

Picture 2.13 Elements relating the vernacular presences in architecture

Approaching the problem from the point of view of Contextualism - a work that expresses the vernacular when it is in harmony with the natural ecological and humane environments of the locality where it was built. This leads to the perception that the aspects reflecting indigenouness in architecture are similar to those of Sustainable Architecture – that is, having a sustainable relationship with natural, cultural, social, economic and technical environments (in which the cultural environment is becoming increasingly important, become the "fourth pillar of sustainable development"[58]): 1) Adapt to local natural conditions; 2) To continue and promote local cultural

traditions; 3) Meeting the practical needs of the people and the community; 4) In accordance with the livelihoods and economic conditions of indigenous peoples; 5) Suitable for local technical capabilities and qualifications.



Picture 2.14. 5 Local Identity Criteria

From the above-mentioned perspectives, the topic "Architectural design guidelines expressing local identity" (Vietnam Association of Architects, 2010)[61] has proposed a set of criteria of 5 groups - including 2 groups on content (ND1-ND2) and 3 groups on form (HT1-HT2-HT3), corresponding to the combined properties into indigenousness in architecture (figure 2.20): - ND1 (Adaptability): adapting to natural conditions and climate, achieving ecological and environmental efficiency; - ND2 (Humanity): in accordance with the cultural traditions, lifestyle, psychology, needs and practical abilities of the local community; - HT1 (Inclusiveness): harmonize organic attachment with the elements of natural landscape

and cultural landscape around the construction site; - HT2 (Integration): integrating cultural values, applying traditional principles of conduct into spatial layout and organization; - HT3 (Contact): use of local construction materials and techniques; use characteristic styles, images, details as signs to identify native origins.

2.3.3.2. Aspects presenting vernacular in architecture

Considering the requirements for sustainability, the vernacular in architecture is manifested in all aspects (Figure 2.21). Looking at the properties that constitute vernacular / local identity:

- Adaptability manifests a sustainable relationship with natural ecological environment; spatial solution orientation and structure covering up to solve natural and environmental problems - on the basis of promoting traditional constructing experience, using technologies, techniques and materials suitable for the localities.

- Humanity determines the relationship between the project and the human ecology of the localities, meeting the needs of people, in accordance with the community culture; towards sustainable efficiency in both Social-Culture and Material-Architecture, with the motto "architecture for people" (of the people, by the people, for the people).

- Inclusion governs architectural form factors (morphology, composition, structure, style, materials, color,..) to create organic bonding with the environment. On the one hand, it requires the harmony of Cultural behavior, Cultural organization and Cultural activities in handling the relationship between architecture and existing natural ecology and human ecology systems. On the other hand, it allows the diversification of form according to the specific correlation between the natural and sociocultural elements of the localities.

- Integration integrates cultural values / vernacular vitality into architecture to integrate impressions. Impact on the shape (layout and organization of space in the traditional way), on architectural details (using familiar images, characteristic details of local architecture to identify). Create a symbolic element to associate - not necessarily with traditional materials, opening up the possibility of modernization with new materials and textures.

- Relevance creates image integration, connecting the shell of the building with the architectural and urban landscape in terms of visual perception. Form is always felt first, widely recognized and also most emotionally - hence the relationship of form with what is present, which is preserved in the human subconscious is an aspect of vernacular in architecture.

2.4. AFFECTING FACTORS TO VERNACULAR PRESENCES IN VIETNAM'S MODERN ARCHITECTURE

2.4.1. Orientation of Vietnam's architecture development

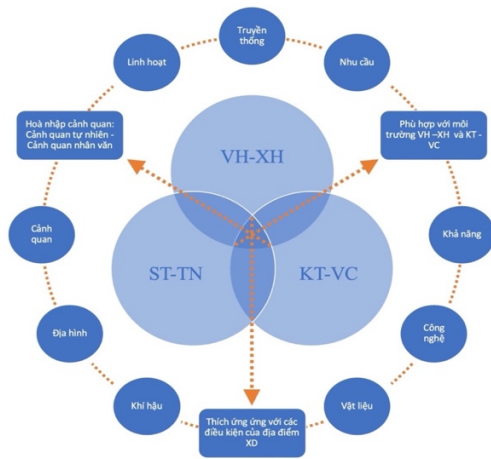

Picture 2.21. Vernacular aspects in architecture

Nationality and modernity have always been intertwined in the Vietnamese culture models in the second half of the 20th century, and the requirement for the harmony between Tradition and modernity has always been defaulted to the mainstream cultural line, which is taken as the orientation of architectural development (as the main component of the object culture). Previously, the traditional model was "cultural community" – based on distributed and relatively independent village communities, but as sustainable

Social-Culture units. Houses in villages and municipalities follow folk experiences and traditional models, so they are similar in form and structure, and the presences is clearly community in architecture.

2.4.2. Technical elements, construction technology and materials

Techniques and materials are always polished to increase convenience and liberate people – but make the way indigenous and local identities increasingly disappear. Modern technology that is not compatible with environment, socioculture and local economy becomes a burden, no longer a tool for development.

There are many constructing technologies suitable for the specific human, ecological and economic and technical aspects of each locality. These are traditional original technologies, which have been improved/upgraded/modernized; exploit practical experience/use of on-site resources; Accepted by the community. Using appropriate technologies will contribute to promoting cultural values, expressing local identity in architecture.

The origin, emotions, color of the material affect the effectiveness of vernacular expression. The nature of the material everywhere is neutral, it only manifests the vernacular characteristics when it is humanized through the way people use it. Therefore, it is possible to use modern materials while still transforming the indigenous spirit into architecture.

2.4.3. Era factors

In the new era, many vernacular traditions are no longer suitable for new people and new needs - leading to the renewal of the spirit of vernacular according to the socialist trend and modernization manifested in accordance with the new aesthetic concept (not stereotyped).

The human spirit of the era towards cultural diversity and value equality (promoting personal roles, creating opportunities for presentation) contradicts the traditional cultural characteristic of community (individuals are bound, must integrate into the community). The trend of human liberation lack of direction / lack of control can lead to negative consequences of socioculture, affecting vernacular awareness and mental health.

Architecture is physically bound and cannot be ahead of its time. Material modernity is only relative, with time and space limits depending on each community, each locality. Mental modernity can be sustained for a long time if re-resonated with the rich culture. The spirit of vernacular combined with the contemporary factor, its expression is of the times without being outdated.

2.5. PRACTICAL EXPERIENCES IN VERNACULAR PRESENCES IN MODERN ARTCHITECTURE

2.5.1. Lessons from Japan’s modern architecture.

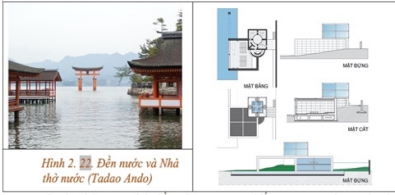

Picture 2. 22. Water Shrine and Water Cathedral (Tadao Ando)

2.5.2. Experiences from metaphor of the Post-Modern American architects



Picture 2. 23. Louvre Museum (Paris)

Picture 2. 15. Memorial Yard .. B.Franklin

Picture 2. 16. Italian Square, New Orleans (USA)

2.5.3. Experiences of vernacularization of hotels & resorts

Following the natural material structures of the local surroundings, expressing the morphological characteristics of coastal locations - through the systems of terrain, landscape, traffic, promenade, architecture, infrastructure,.. in the resort. Especially, the continuous water surface chain connects from the main hall > the iconic lake > the landscaped lake > the pool > the sea. Maximum integration of local sociocultural characteristics into activity content and forms of functional areas in the resort to create a highly consistent architecture (from the overall and general landscape to each individual item, each interior space). Thereby creating many opportunities for visitors to be exposed to the vernacular context in a visual, direct, frequent and diverse way. Then through the experience and exploration of environment and the architectural landscape that orients the emotions and perceptions of visitors about the "soul of the place", "Identity of the place" in the resort.

CHAPTER 3. REGULATE AND RAISE THE EFFECTIVENESS OF THE VERNACULAR CHARACTERISTICS IN VIETNAM’S MODERN ARCHITECTURE

3.1. Ways of presenting vernacular in Vietnam modern architecture

3.1.1. Structures of vernacular presentation

The vernacular presences in architecture contains of two unified nuclear aspects – the Internal (perception / awareness of the vernacular in architecture) and the External (architectural presentation).

Table 3. 1. Structures of vernacular presences in architecture

The vernacular structure in architecture	
Internal: the vernacular meaning	Internal: the vernacular meaning
Content: the vernacular vitality (of the destinations and the people)	Content: the vernacular vitality (of the destinations and the people)
Quality: Characteristics, Properties, Nature Generalization / Popularity (→ Perception)	Quality: Characteristics, Properties, Nature Generalization / Popularity (→ Perception)
Scope: Unify the natural ecology with the human ecology in the local	Scope: Unify the natural ecology with the human ecology in the local
The local vernacular surroundings	
The stabilities: The original vernacular elements	The stabilities: The original vernacular elements

The natural ecology and sociocultural ecology The vernacular prototypes			The natural ecology and sociocultural ecology The vernacular prototypes		
The original vernacular elements → regular, overarching impacts			The original vernacular elements → regular, overarching impacts		
Structure of vernacular presentation					
Primary structure: Material making principles + Structure + Shape → Vernacular prototypes and patterns			Primary structure: Material making principles + Structure + Shape → Vernacular prototypes and patterns		
In-depth structure (content, meaning) Perception of vernacular vitality and tradition (connect and develop the perceived)			In-depth structure (content, meaning) Perception of vernacular vitality and tradition (connect and develop the perceived)		
Tradition (past → present) → Continue and Develop (Reform)			Tradition (past → present) → Continue and Develop (Reform)		
Ways of presenting vernacular					
(1) Self Method: Vernacular meaning + Vernacular materials → Original vernacular presentation			(1) Self Method: Vernacular meaning + Vernacular materials → Original vernacular presentation		
(3) Combine Method: Vernacular vitality + Vernacular materials / Reform vernacular → New vernacular presentation					
Vernacular content → Encode → Vernacular symbols and codes			Vernacular content → Encode → Vernacular symbols and codes		
Reference (Signified)	Reference (Signified)	Reference (Signified)	Reference (Signified)	Reference (Signified)	Reference (Signified)
Ways of presenting: Demonstration, Symbolization, Complementation (Transform local traditions into architecture) Metaphor, Insinuation (through architectural signs as the vernacular symbols and codes)			Ways of presenting: Demonstration, Symbolization, Complementation (Transform local traditions into architecture) Metaphor, Insinuation (through architectural signs as the vernacular symbols and codes)		

3.1.2. Ways of presenting vernacular in architecture



Picture 3.2. vernacular presences progress

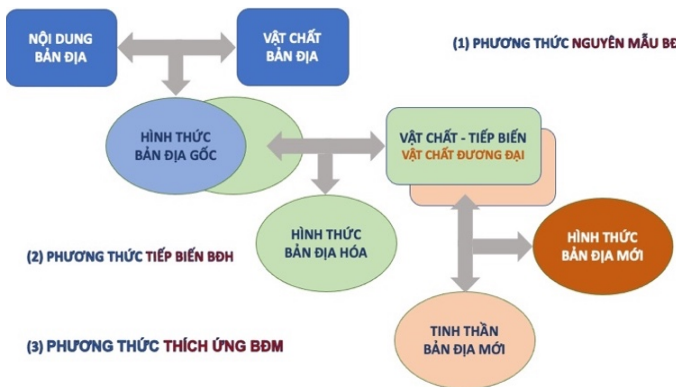

Picture 3.2. Vernacular relationships

There are 3 ways to present the vernacular presences throughout the history: 1/ Self Method: Vernacular meaning + Vernacular materials → Original vernacular presentation; 2/ Modify Method: Vernacular presentation + Modern materials → Enhanced vernacular presentation; 3/ Combine Method: Vernacular vitality + Modern materials → New vernacular presentation.

In the past, the vernacular was presented by the Self Method which formed Original vernacular presentation (prototypes); by the Modify Method forming Enhanced vernacular presentation (variations / styles). Nowadays, the Combine Method is a modern way which uses new tools (modern technologies and materials) to show the vernacular vitality, leading to the New vernacular presentation (also the Vernacular under modern elements).

3.1.3. Structures of the local vernacular surroundings

The local vernacular surrounding is a complex combination of the original vernacular elements from the local natural ecology and human ecology. Regarding the presentation in architecture, the local vernacular surrounding can be considered as a parallel pair between the vernacular environment (the content aspect) and the vernacular landscape (the presentation aspect) – in which the vernacular environment is the primary element while the vernacular landscape is the secondary. Such local vernacular surrounding needs time to develop, with the foundation of the primary structure (including the natural ecology environment in combination with the sociocultural and material-economic environment), and strengthened by the secondary structure (including the original vernacular elements, the natural-cultural-economic-urban surrounding and other modern factors). The primary structure (environment) and the secondary structure (landscape) is designed on top of each other by a common vitality of the vernacular presences (Picture 3.3; 3.4; 3.5; 3.6; 3.7).

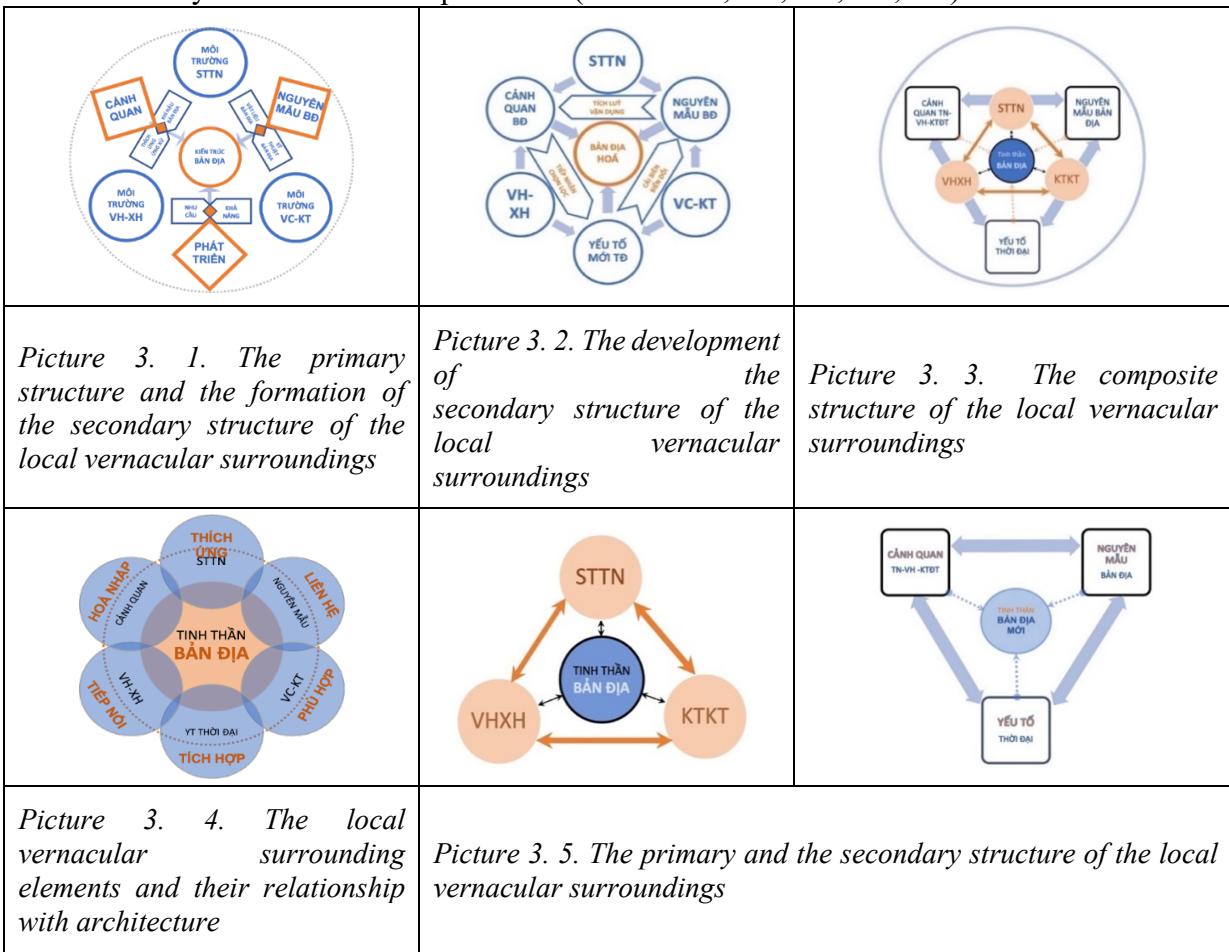

3.1.4. Vernacular presences elements in architectural construction

In general, the architectural presentation consists of three symbolized components, which are the Roof + the Body + the Foundation.



Picture 3. 1 The Foundation



Picture 3. 2 The Body

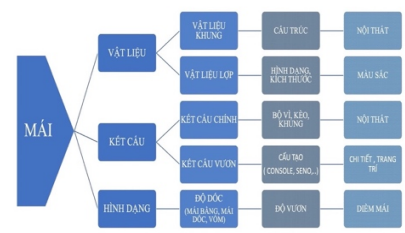

Picture 3. 3. The Roof

3.2. Identify the vernacular presences in Vietnam modern architecture

3.2.1. Determine criteria groups of vernacular presentation in architecture

The vernacular presences in architecture (including the internal aspect and external aspect presentation – Picture 3.1) contains the combination of primary and secondary structures (of constructive relationship), in-depth structure and outer-layer structure (of expressing language). The primary structure and the in-depth structure belong to the Internal of the vernacular in architecture. The secondary structure and the outer-layer structure (building presentation and architectural

language) belong to the External – these are the signs to identify the vernacular presences

The Internal of the problem is the perception of local vernacular/identity in architecture - reflecting indigenous spiritual elements and indigenous content. The External of the problem is the expression of local vernacular / identity - in indigenous material elements and indigenous forms. From there, the expression of vernacular in contemporary architecture can be determined through the relationship with aspects of the vernacular environment.

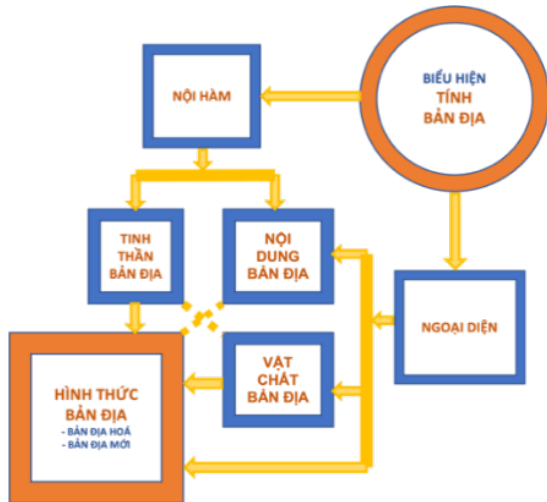

Picture 3. 4. Internal and External of vernacular presences

Table 3. 1. The criteria groups identifying vernacular presences in Vietnam’s modern architecture

TT	SURROUNDINGS ASPECTS	SURROUNDINGS ELEMENTS		COMMON CRITERIA
Internal	<i>Vernacular vitality</i>		<i>Vernacular vitality</i>	Convey feelings, awareness of the vernacular vitality
	<i>Vernacular content</i>		<i>Natural ecology</i>	Adapt to the natural ecology
			<i>Socialcultural ecology</i>	Adapt to the sociocultural ecology
External	<i>Vernacular materials</i>		<i>Material-Architectural elements</i>	Suitable materials and technology
			<i>Modern elements</i>	Implementing new elements
	<i>Vernacular presentation</i>		<i>Vernacular prototypes</i>	Relating to the vernacular prototypes
			<i>Vernacular landscapes</i>	Blend in with the vernacular landscape

3.2.2. Construct criteria system to identify the vernacular presences in modern architecture

On the basis of the problem structure of the vernacular and environmental groups, 7 groups of thesis framework criteria determine the structure diagram of the system of criteria for identifying vernacular presences according to the following diagram (Picture 3.12).

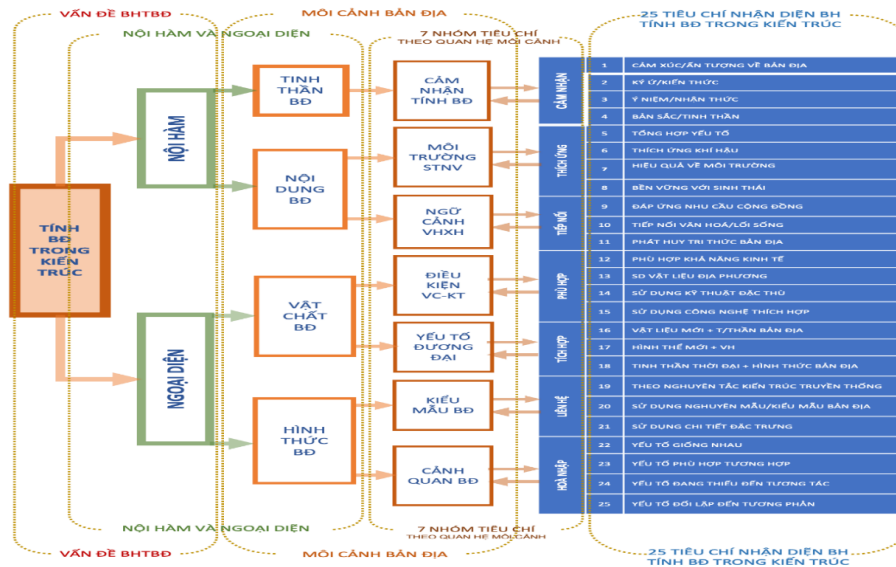

Picture 3. 5. Vernacular presences Criteria System Diagram

Table 3. 2. Vernacular presences Criteria System

SURROUNDINGS ELEMENTS		FACTORS	CRITERIA		METHOD
Vernacular vitality	Feeling	Emotions	1	Recalling familiar impressions/emotions of the vernacular vitality (unconscious)	Metaphor
			2	Reminiscent of the image in the memory of the vernacular (subconscious)	
		Consciousness	3	Symbolizing the concept/ awareness of the the vernacular vitality (consciousness)	Symbolization
			4	Transforming the spirit of vernacular from the environment into architecture (action)	
Natural Ecology	Adaptability	Natural and Climate conditions	5	Respect the natural elements inherent in the locality	EE-1
			6	Adapt to the climate - even with ongoing change	
		Natural ecology	7	Environmental efficiency / improvement of habitat quality	EE-2
			8	Comprehensive and Long-Term Adaptation / Ecological Sustainability	EE-3
Sociocultural ecology	Continuity	Society	9	Meet the needs and serve the activities of the community	
		Culture and Lifestyles	10	Continuation of the cultural tradition; Respect for living habits.	
		Vernacular knowledge	11	Exploiting / promoting folk experiences and behaviors	
Material-Architectural elements	Suitability	Economy	12	In line with the living standard and economic capacity of the community	
		Materials	13	Use of characteristic/familiar/locally available materials	
		Technique	14	Performed using local-specific construction techniques	
		Technology	15	Use technology appropriate to local conditions	
Era elements	Integration	New materials	16	Express the spirit of vernacular with new materials → new form of vernacular	Symbolization
		New shapes	17	Integrating traditional cultural values into new shapes	Integration

		New meaning	18	Combining the form of vernacular with the spirit of the new era / people	
Vernacular prototypes	Relation	Structure	19	Spatial structure, layout, combination according to the principle of traditional	Symbol and Encode
		Prototype	20	Use prototypes/models, forms/models	
		Detail	21	Use of architectural details, decorations, characteristic structures	
Vernacular landscapes	Integration	Similarity	22	Use the same elements to get along with the environment	Contribution
		Correspondence	23	Use elements that match the characteristics of the environment	Complementary
		Interaction	24	Add missing elements to create balance for the environment	Complementary
		Contrast	25	Use the opposite element in unity to stabilize the environment	Opposition

3.2.3. Vernacular presences in Vietnam's modern architecture

The set of criteria for identifying vernacular expression (including 7 groups and 25 component criteria) is used to identify vernacular presences in Vietnam's modern architecture, on the basis of reviewing and analyzing the visual information obtained about the components and characteristics of the building. Visual information includes actual images, graphics, drawings, design profiles,.. Accurate enough to get reliable identification. In order to identify sensitively, to recognize a sign that is a manifestation of vernacular - the researcher needs to grasp more specific data about the specific vernacular environment of the locality.

Table 3. 3. Vernacular presences in Vietnam's modern architecture

HỆ THỐNG CÁC TIÊU CHÍ NHẬN DIỆN BIỂU HIỆN TÍNH BẢN ĐỊA			BIỂU HIỆN TÍNH BẢN ĐỊA TRONG KIẾN TRÚC CÔNG TRÌNH ĐƯƠNG ĐẠI VIỆT NAM - TÊN CÔNG TRÌNH		
NHÓM TIÊU CHÍ	TIÊU CHÍ THÀNH PHẦN	QUAN HỆ BIỂU HIỆN	HÌNH ẢNH THỰC TẾ - BẢN VẼ KIẾN TRÚC	CẢM NHẬN TÍNH BẢN ĐỊA	
1. Tinh thần BD	Cảm nhận	1	Gợi lại ấn tượng / cảm xúc quen thuộc về tinh thần BD (vô thức)		MÔ TẢ CU THỂ - DIỄN GIẢI - Ý NGHĨA (NHÓM TIÊU CHÍ 1)
		2	Gợi liên tưởng đến hình ảnh trong ký ức về cái BD (tiềm thức)	▲	
		3	Biểu trưng hóa ý niệm / nhận thức về tinh thần BD (ý thức)		
		4	Chuyển hóa tinh thần BD từ môi cảnh vào kiến trúc (hành động)	▲	
2. Môi trường STTN	Thích ứng	5	Tồn trong các yếu tố tự nhiên vốn có của địa phương		MÔ TẢ CU THỂ - DIỄN GIẢI - Ý NGHĨA (NHÓM TIÊU CHÍ 2)
		6	Thích ứng với khí hậu - kể cả với sự biến đổi đang diễn ra		
		7	Hiệu quả về môi trường / cải thiện chất lượng môi trường sống	▲	
		8	Thích ứng toàn diện và lâu dài / Bền vững về sinh thái	▲	
3. Môi trường VH-XH	Tiếp nối	9	Đáp ứng nhu cầu và phục vụ hoạt động của cộng đồng		MÔ TẢ CU THỂ - DIỄN GIẢI - Ý NGHĨA (NHÓM TIÊU CHÍ 3)
		10	Tiếp nối truyền thống VH; tôn trọng tập quán sinh hoạt	▲	
		11	Khai thác / phát huy các kinh nghiệm và ứng xử dân gian		
4. Các yếu tố VC-KT	Phù hợp	12	Phù hợp với mức sống và khả năng kinh tế của cộng đồng		BIỂU HIỆN THEO 2 NHÓM TIÊU CHÍ 3 VÀ TIÊU CHÍ 4
		13	Sử dụng vật liệu đặc trưng / quen thuộc / sẵn có ở địa phương	▲	MÔ TẢ CU THỂ - DIỄN GIẢI - Ý NGHĨA (NHÓM TIÊU CHÍ 2)
		14	Thực hiện bằng kỹ thuật XD đặc thù của địa phương		
		15	Sử dụng công nghệ thích hợp với điều kiện địa phương	B	BIỂU HIỆN THEO 2 NHÓM TIÊU CHÍ 4 VÀ TIÊU CHÍ 4
5. Yếu tố thời đại / đương đại	Tích hợp	16	Thể hiện tinh thần BD bằng vật liệu mới → hình thức BD mới		MÔ TẢ CU THỂ - DIỄN GIẢI - Ý NGHĨA (NHÓM TIÊU CHÍ 5)
		17	Lồng ghép các giá trị VH truyền thống vào hình thể mới		
		18	Kết hợp hình thức BD với tinh thần của thời đại / con người mới	▲	
6. Các kiểu mẫu BD	Liên hệ	19	Cấu trúc không gian, bố cục, tổ hợp theo nguyên tắc truyền thống		MÔ TẢ CU THỂ - DIỄN GIẢI - Ý NGHĨA (NHÓM TIÊU CHÍ 6)
		20	Sử dụng các nguyên mẫu / kiểu mẫu, hình thức / mô thức BD	▲	
		21	Sử dụng các chi tiết kiến trúc, trang trí, cấu tạo đặc trưng		
7. Cảnh quan BD	Hòa nhập	22	Sử dụng các yếu tố giống nhau để hòa đồng với môi cảnh		BIỂU HIỆN THEO CẶP 2 TIÊU CHÍ 6 VÀ 7
		23	Sử dụng các yếu tố phù hợp với đặc trưng của môi cảnh		
		24	Bổ sung các yếu tố còn thiếu để tạo sự cân bằng cho môi cảnh		
		25	Sử dụng yếu tố đối lập trong sự thống nhất để ổn định môi cảnh	▲	
TỔNG	0 25	Thành tố cấu thành Biểu hiện tính bản địa trong kiến trúc công trình	0	GHI CHÚ: ▲ Là ảnh minh họa / hình vẽ biểu hiện theo từng nhóm tiêu chí. B Là hình ảnh biểu hiện chung của 2 nhóm	

3.2.4. Apply the criteria system in some modern architectural works in Vietnam

The thesis has applied the Vernacular presences Criteria System on these modern architectural works: 1/ 3.2.4.1. Dak Lak Museum; 2/ 3.2.4.2. Hanoi Museum; 3/ 3.2.4.3. The Museum of Dien Bien Phu Victory.

3.3. Raise the effectiveness in the vernacular presences in Vietnam’s modern architecture

3.3.1.1. Orientation perspective: The thesis proposes the general orientation point is to take the

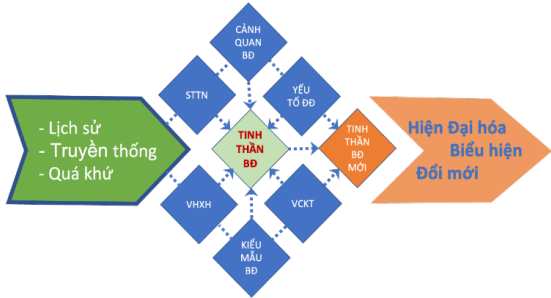

Picture 3.6. Orientation on vernacular presences in Vietnam’s modern architecture

integrated method (Vernacular Vitality + Contemporary Material → New Form of Vernacular) as the main method to express vernacular in accordance with the orientation of architectural development "advanced and rich in identity". The orientation model (figure 3.13) also proposes a continuous process from research to architectural design:

3.3.1.2. Characteristic induction of the environment according to the Five Elements.

3.3.1.3. Developing Indigenous Spiritual Content

Factors that need to be taken care of to develop the spirit of vernacular and the renewal of presences of vernacular in contemporary architecture: The new vernacular vitality does not escape the tradition - but contributes to perfecting vernacular values, towards what is more suitable for people and the environment. Architecture carries the breath of the times - through the appropriate use of technology, technology and materials to serve people more conveniently (→ upgrade the flexible characteristics of traditional architecture); organize space more effectively for the exploitation of locations and proactively respond to climate change (→ overcome the inadequacies of folk experience and vernacular models); create a richer and more meaningful visual MT (→ diversifying form compared to traditional architecture); ..

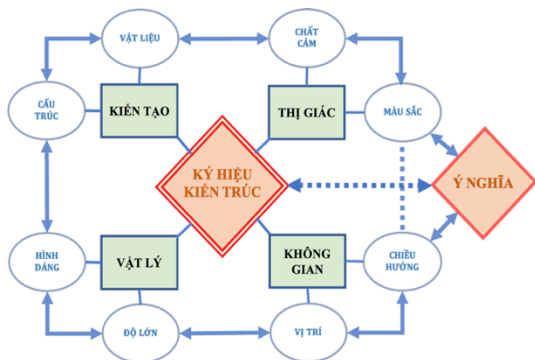

Hình 3. 6 Ký hiệu kiến trúc gắn với Ý nghĩa mã ĐĐ

3.3.1.4. Exploiting the form of indigenous matter: Form - vernacular material is a means to transform the spirit of vernacular (which is an abstract concept) into specific images and structures (on the basis of the coordination of meaning elements → Symbols → Interpretation). Traditionally belonging HT-VC aspects are preserved physical heritages - prototypes, patterns. Materially modernized forms of vernacular will become new forms of vernacular; And the form of adaptation to the new vernacular vitality will be the form of vernacular.

3.3.1.5. Vernacular mental expression in

accordance with the mind and cultural behavior In order to perceive and continue the spirit of vernacular, it is necessary to analyze the vernacular source factors of the localities, in both aspects - the natural landscape (terrain, terrain, water surface, flow, trees,..) and cultural landscape (architectural appearance, urban image, living scene,..) - thereby identifying the characteristics of the environment and cultural characteristics. Special attention is paid to the vicinity of natural heritage sites (famous landscapes), around architectural and urban heritages (sites, monuments, population heritage,..) - often places where local vernacular/ traditional values are hidden. Morphological and structural analysis to clarify the characteristics and properties of the environment, relying on correlations between components to determine the direction

3.3.2. Maintain the effectiveness of vernacular presences in Vietnam's modern architecture

3.3.2.1. Transforming local identity into architecture: From a structural point of view, the form of the environment (environment and landscape) contains deep layer structures that affect perception and are associated with human emotions. Materialize structures everywhere are associated with Tectonics, which adhere to dialectical laws of unity and transformation between opposites, and reflect the etho of the vernacular spirit there. Within the defined space of the locality, architecture is the artificial structure that makes up the organic unity between vc natural structures and human activities there, creating corresponding emotions, perceptions and experiences. Therefore, architecture is considered a phenomenon of the vernacular environment and thereby reflects the spirit of vernacular, BSC.

3.3.2.2. Architecture in harmony with the vernacular environment: With the methods of displaying and supplementing, there is no specific quantitative indicator to determine whether an element is more or less, redundant or lacking, but must be based on the stable equilibrium of the whole (determined by the Five Elements). Everything, phenomena in the world of natural and social (whether physical, intangible, immutable, moving - including time) can be attributed to the Five Elements to determine the nature and nature of its relationships. From applying the Five Elements principle to identifying the characteristics of the vernacular environment (3.3.1.2), it is possible to determine the morphological characteristics of the architectural works that are implanted in a way that is properly implanted. It is impossible to take a large scale to oppress TN, change the structure of TN 's being - however, a small but well-placed architecture will contribute to strengthening and perfecting the general environment of the region and adding meaning and value to itself.

3.3.3. Vernacular presences in Materialized Form

3.3.3.1. Induction of Artificial Materials according to the Five Elements

One of the factors that have an important role, directly affecting the ability and efficiency of vernacular in e-commerce - is the new types of constructing materials and finishing materials, accompanied by modern construction technologies and techniques.

Reinforced concrete, glass, fabric, plastic, plastics,.. These are very common materials in modern and contemporary architecture – but are not present in nature as well as in traditional architecture because they were only invented, manufactured, popular in the twentieth century. However, these artificial materials themselves are capable of carrying characteristics, properties, morphology,.. of different onions - arising from the impact of special conditions, extreme factors in the fabrication process. Thus, the characteristic induction of artificial materials according to the Five Elements will be the basis for coordinating them with natural original materials in a way that complements the environment, to the architecture effectively – at the same time bringing the ability to innovate, enriching and modernizing presences of vernacular.

3.3.3.2. Symbolizing the perception of vernacular through Association and Metaphor

The Symbolization method using the tool is symbols (encrypted form elements), based on conceits and metaphors.

The expression "symbolism" is easy to direct people to the use of only a few typical images, which are generally recognized as symbolic, and often historical. That will cause the ancient mattress architecture and form to overlap (monotonous, boring). In most other cases, it is entirely possible to use the more conventional methods of metaphor and association to express the concept/feel of the vernacular vitality to varying degrees – allowing for the creation of diversity and vividness for architecture.

3.4. Review on the thesis's results

3.4.1. Review on the vernacular presenting methods in Vietnam's modern architecture

The thesis has inherited the results of previous studies, in the spirit of coordinating different perspectives between the perspectives "from the inside out" and "from the outside", between the approaches of "vernacularize modern architecture" and "modernization of vernacular architecture". This convergence is the premise for the creation of "Mo-dentical = Modern + Identical" mobile phones, which are also "global response and adaptation to the localities" (Glo-cal). The results of the thesis have allowed the formation of a consistent and logical method of vernacular that can be applied to architectural design.

One issue that requires further studies to clarify - is the role of the cultural factor (in relation to the "Cultural Identity"). In this direction, what is the identity of Culture? To what extent is it retained in practice (after 1954-1986 and the early period of 1990-)? Are traditional cultural standards and values still in line with the needs of the new era? Is there an opportunity to continue to exist, capable of continuing and promoting? And when there are many ethnic groups and stable residents for a long time in one area - can the unique cultural characteristics of each ethnic group be unified and coordinated in the "common" cultural identity of the locality?

It can be seen that although the natural conditions are the same, the different subject is difficult to have a common cultural identity - so the local identity (or the vernacular vitality) will only selectively take the similar characteristics and leave the ability to promote characteristics and identity for each people. The specific vernacular presences will depend on the composition, size and distribution of residential communities (independent, intertwined, intersecting), as well as the natural behavior of people (derived from the mind) and popular behavior of the community (Cultural behavior).

The structuring the vernacular presences allows for comprehensive and dialectical awareness of this issue. Vernacular characteristics, vernacular vitality or local identity in architecture are not immutable from the past, but develop with people who, over time, continue the tradition flexibly and creatively to adapt to the spirit of the times. With this view, the thesis clarified the structure of the vernacular environment, systematized the aspects of the vernacular presences in architecture, the possibilities and location of vernacular presences associated with the structure of the building.

3.4.2. Review on the vernacular presences Criteria System in Vietnam's modern architecture

This is a set of framework criteria for identifying and verifying the vernacular presences in architecture - not to assess the quality of architecture or compare levels more poorly, nor to replace the content of the concepts of "vernacular" / "local identity". Its purpose is to improve and improve the efficiency of vernacular presences in the process of studying architectural design. The efficiency of vernacular presences is recognized by the depth of meaning of the content and the strong richness of the appearance.

3.4.3. Review on Regulating and Raising effectiveness of vernacular presences in Vietnam's modern architecture

The scope of vernacular presences depends on the specific environment of each unit. It is not the administrative boundaries for decentralization and scale management – but the area with the convergence of the impact of the original vernacular factors, in which the individual scopes (according to each group of factors) can be different and not completely coincide, homogeneity. The range of space (related to natural geographic factors) is the widest, but is usually stable and relatively well established. The scope of time (related to traditional, historical, process factors) can overlap, integrate, integrate with each other. The scope of the human being (in relation to ethnicity and Social-Cultural factors) is the most complex, able to spread, shrink, transform, expand, intertwine – along with the increase in population composition, population density and area of residence. Therefore, it is recommended to approach from a Local - cultural perspective to have an overall view.

CONCLUSIONS AND RECOMMENDATIONS

1. CONCLUSIONS

1/ The thesis has conducted an overview of the vernacular problem system in architecture and in studies related to the topic; consider the expression of vernacular in relation to the national and international aspects, traditional and modern, placed in the context of the development of contemporary social development.

2/ The thesis has established the scientific basis of health insurance of vernacular in architecture - including the research approach, 3 groups of theoretical basis (on the relationship between architecture and place, with the cultural system and with the language system), the group of influencing factors and experience.

3/ The thesis has systematized the theoretical and cognitive views on the issue of expression of vernacular in architecture; Since then, the system of aspects of vernacular expression in the structure of the building, the components of the vernacular environment has been established and indicated the methods of expression of vernacular in architecture.

4/ On the basis of clarifying the nature of the relationship between architecture and aspects of the vernacular environment, the thesis has developed a system of criteria (consisting of 07 groups - with 25 component criteria) to guide the expression and identify the signs of expression of vernacular in contemporary architecture in Vietnam.

5/ Applying the system of identification criteria, the thesis has proposed orientations to improve the effectiveness of vernacular in contemporary architecture in Vietnam. On that basis, it has formed a consistent and logical method of vernacular, capable of applying to architectural design.

2. RECOMMENDATIONS

In order for the research results to be applied in practice and effectively promoted the expression of vernacular in contemporary Architecture of Vietnam, the thesis proposes:

1/ On the basis of the framework criteria of the thesis, authorities at all levels should continue to study and establish specific vernacular codes for localities to serve the architectural design as well as appraisal and management of Urban Planning - Architecture.

2/ Architectural training schools need to supplement the issue of vernacular (with content and duration in accordance with the context of the DP) in the training program; there are plans to put into teaching in terms of theory, research and practice.

3/ Within the framework of the Law on Architecture, the Vietnam Association of Architects should organize research and training activities on Vernacular in Architecture (in the annual professional training program - CPD) to strengthen the awareness of architects and improve the efficiency of practice activities.

LIST OF THE PUBLISHED WORKS RELATING TO THE DOCTORAL THESIS

1/ Tran Manh Cuong (2020), Vernacular in Architecture, Architecture Magazine, Vietnam Institute of Architects, Ministry of Construction No. 304 August 2020. ISSN:0866-8617.

2/ Tran Manh Cuong (2020), Vernacular impacts in Vietnam architecture, Architecture Magazine, Vietnam Institute of Architects, Ministry of Construction No. 305 September 2020. ISSN:0866-8617.

3/ Tran Manh Cuong (2021), Proper Understanding on Vernacular in Architecture, Vietnam Architecture Magazine, National Architectural Institute. Number 233-2021. ISSN:0868-3768.

4/ Tran Manh Cuong (2021), Vernacular presences Criteria System in Vietnam's modern architecture, Architecture Magazine, Vietnam Institute of Architects. Ministry of Construction November 2021. ISSN:0866-8617